

**Application to New York City Landmarks Commission:
LPC#: 19.27867**

Proposal for the exterior renovation on the 5th floor
backyard exterior at 20 East 95th Street, New York, NY 10128
in the Carnegie Hill Historic District.

- 1 COVER SHEET
- 2 PROJECT LOCATION
- 3 PROJECT SCOPE OF WORK
- 4 AREA OF WORK EXISTING CONDITIONS
- 5 PROPOSED AREA OF WORK RENDER
- 6 PROPOSED DETAILS
- 7 SURROUNDING NEIGHBORS: 94TH ST REARS
- 8 SURROUNDING NEIGHBORS: 95TH ST REARS
- 9 EXISTING PHOTO AND RENDERED PROPOSED

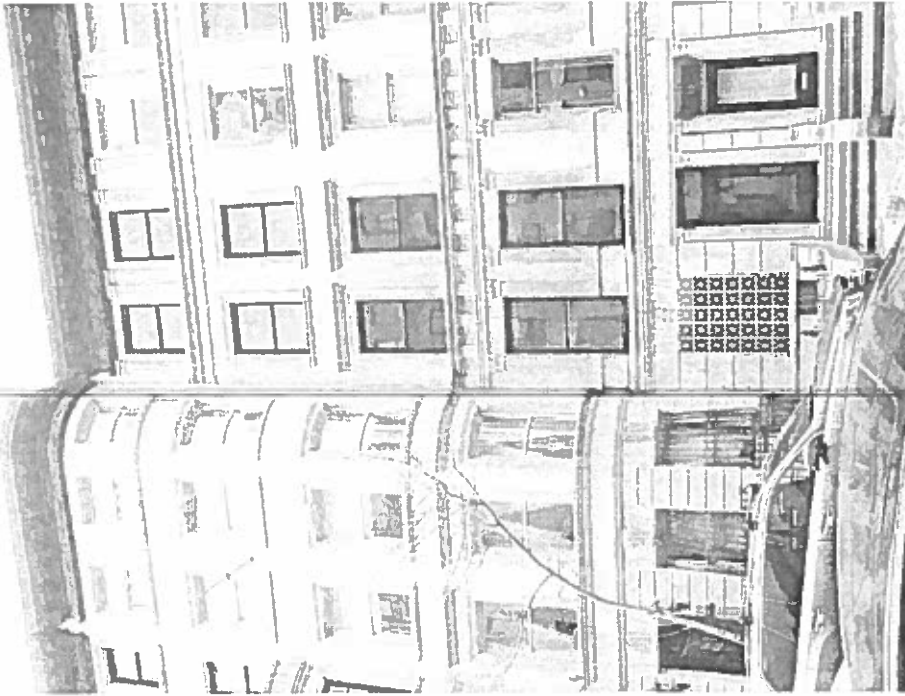

**The Gonzalez De Cosio
Residence**

Residential Townhouse:
Exterior Backyard Facade Proposal

Work in remainder of building was approved by
LPC under Docket #19-1667

Residential Townhouse: Exterior Backyard Facade Proposal	Project Name: The Gonzalez De Cosio Residence	Project Address: 20 East 95th Street New York, NY 10128	Sheet Name: Cover Sheet	Architecture by: Joan Humphreys, RA ARCitecture	THE RENOVATED HOME <small>THE DESIGN RENOVATION AUTHORITY™</small>
NYC LANDMARKS COMMISSION 20 EAST 95 TH ST 1					

Carnegie Hill Historic District

Surrounding Homes

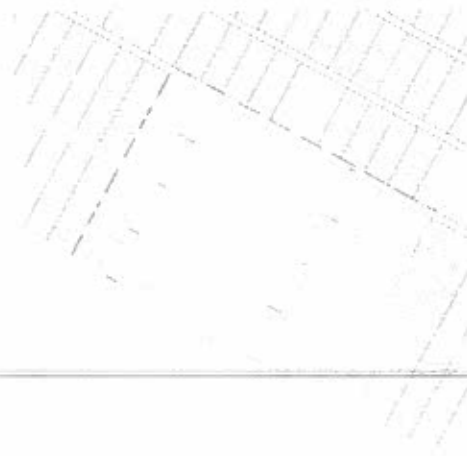

LOCATION OF PROJECT WITHIN DISTRICT

Residential Townhouse: Exterior Backyard Facade Proposal	Project Name: The Gonzalez De Cosio Residence	Project Address: 20 East 95th Street New York, NY 10128	Sheet Name: Project Location	Architecture by: Joan Humphreys, RA ARCitecture	THE RENOVATED HOME <small>THE DESIGN RENOVATION AUTHORITY, INC.</small> NYC LANDMARKS COMMISSION 20 EAST 95 TH ST 2
---	---	---	--	---	---

**SOUTH ELEVATION
CURRENTLY APPROVED**

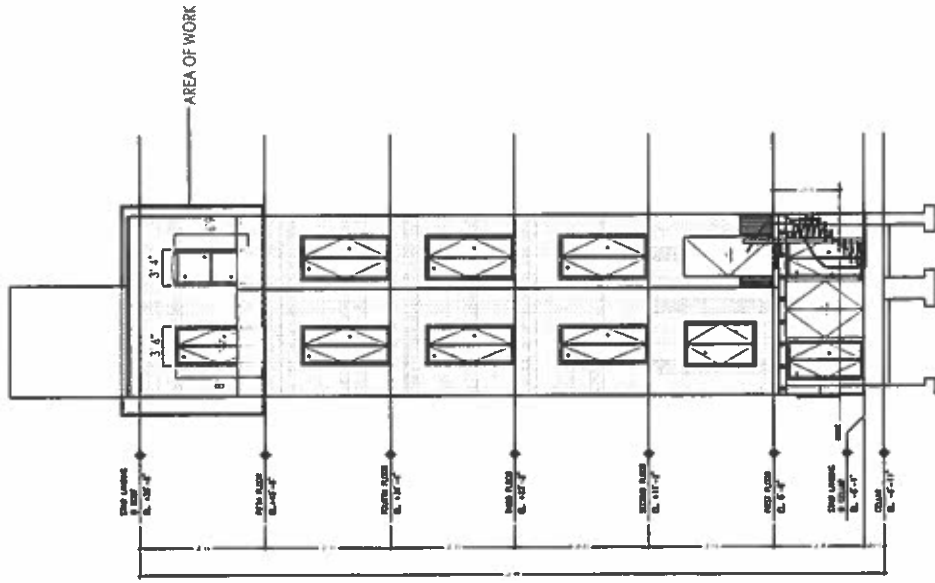

**SOUTH ELEVATION
PROPOSED**

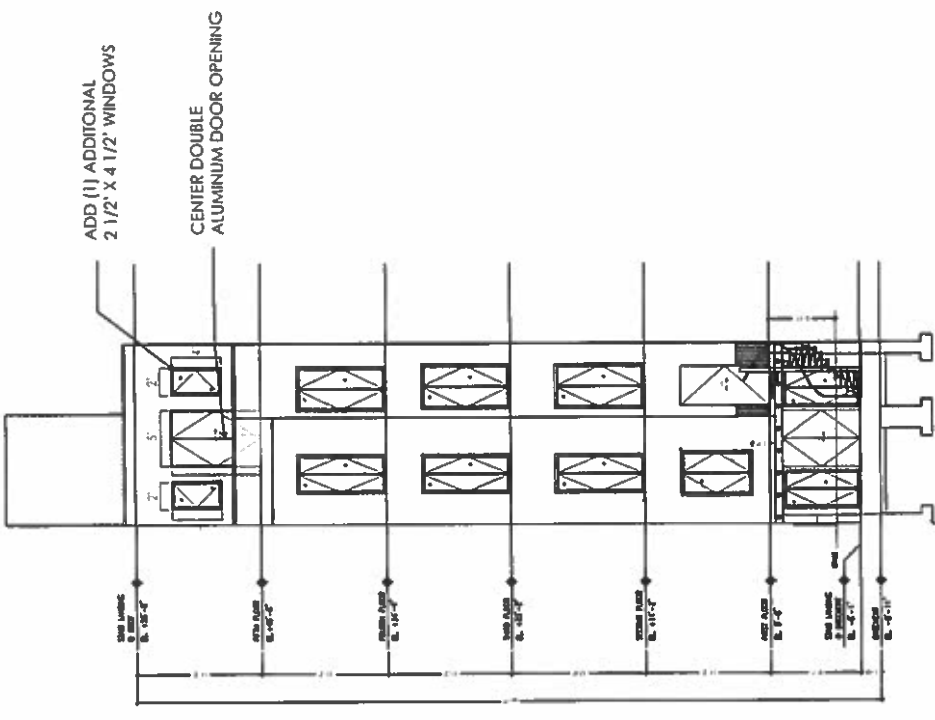

THE RENOVATED HOME
THE DESIGN RENOVATION AUTHORITY™
NYC LANDMARKS COMMISSION | 20 EAST 95TH ST | 3

Architecture by:
Joan Humphreys, RA
ARCitecture

Sheet Name:
Project Scope of Work

Project Address:
**20 East 95th Street
New York, NY 10128**

Project Name:
The Gonzalez De Cosio Residence

**Residential Townhouse:
Exterior Backyard Facade Proposal**

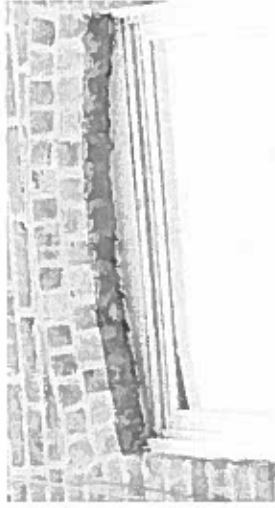

EXISTING WINDOW CONDITIONS IN DISREPAIR

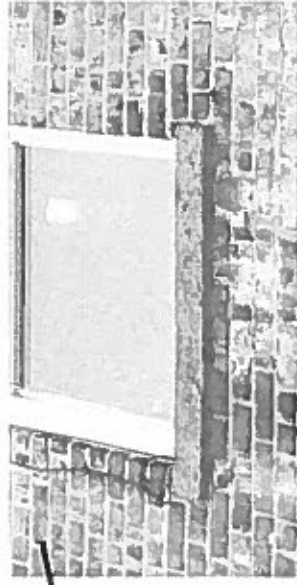

EXISTING WINDOW CONDITIONS IN DISREPAIR



EXISTING WINDOW CONDITIONS IN DISREPAIR

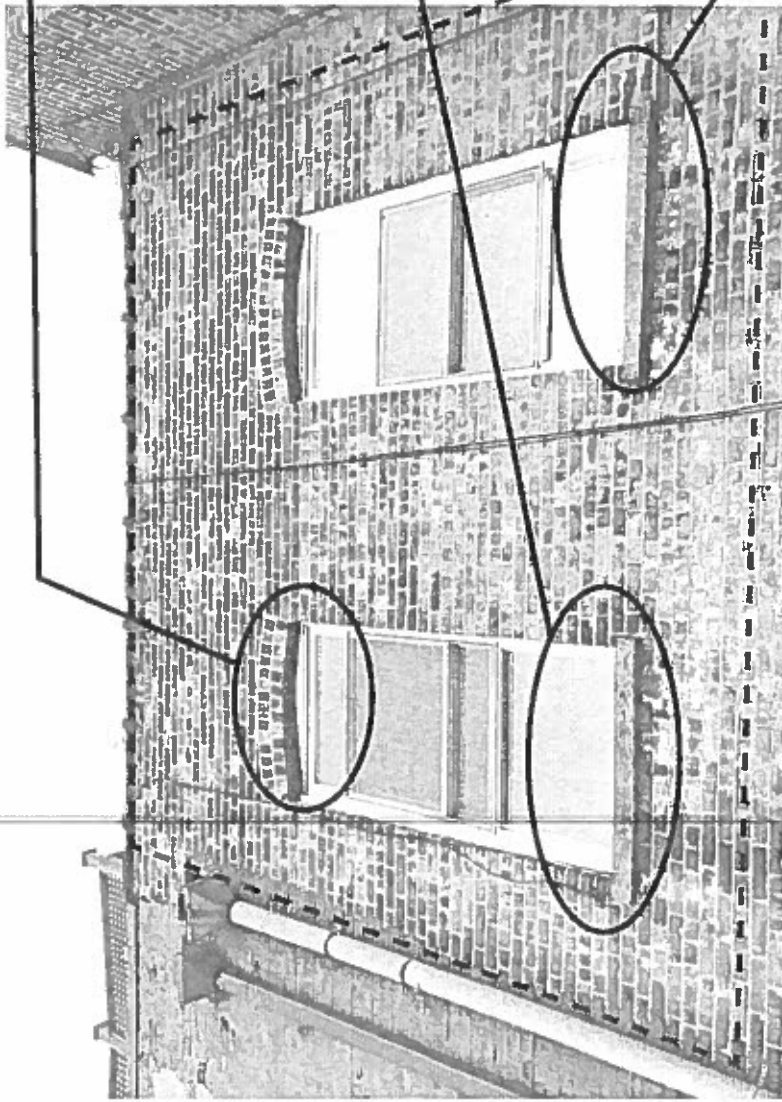

EXTERIOR FACADE OF BACKYARD 5TH FLOOR
WITH OUTLINED SCOPE OF WORK

SCOPE OF WORK:

Restoration of existing masonry.
Installation of 1 additional window to symmetrically match throughout back exterior.
Centering door opening.

<p>Project Name: The Gonzalez De Cosio Residence</p>	<p>Project Address: 20 East 95th Street New York, NY 10128</p>	<p>Sheet Name: Area of Work Existing Conditions</p>	<p>Architecture by: Joan Humphreys, RA ARCitecture</p>	<p>THE RENOVATED HOME <small>THE DESIGN RENOVATION AUTHORITY</small></p> <p>NYC LANDMARKS COMMISSION 20 EAST 95TH ST 4</p>
---	---	--	---	--

Residential Townhouse:
Exterior Backyard Facade Proposal

-BULKHEAD-

STAIR LANDING
@ ROOF

EL. +56' -8"



11'-2"

4'-6"
3'-5"
6"

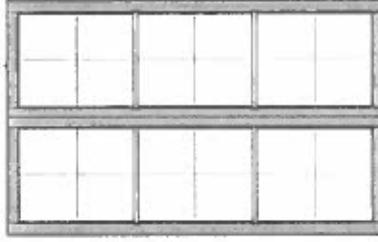

FIFTH FLOOR



EL. +45' -6"

SOUTH ELEVATION - EXTERIOR ELEVATION AREA OF WORK- PROPOSED RENDERED

Residential Townhouse:
Exterior Backyard Facade Proposal

Project Name:
**The Gonzalez
De Cosio
Residence**

Project Address:
**20 East 95th Street
New York, NY 10128**

Sheet Name:
**Proposed
Area of Work
Rendering**

Architecture by:
**Joan Humphreys, RA
ARCitecture**

THE RENOVATED HOME
THE DESIGN | RENOVATION AUTHORITY™

NYC LANDMARKS COMMISSION | 20 EAST 95TH ST | 5

KLOBE ULTRA SERIES - DOOR ELEVATION
TRIMS TO BE PAINTED BLACK

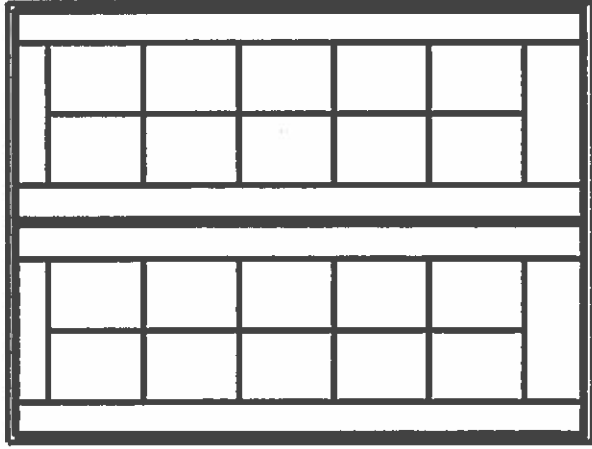

SPU41166

SIDE WINDOWS
ELEVATION
TRIMS TO BE PAINTED BLACK

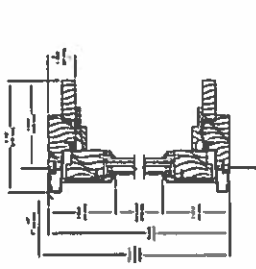

VERTICLE CROSS SECTION

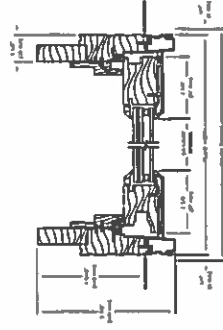

HORIZONTAL CROSS SECTION

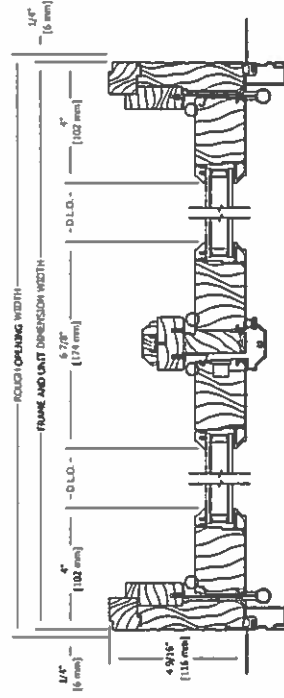

KLOBE ULTRA SERIES - HORIZONTAL SECTION

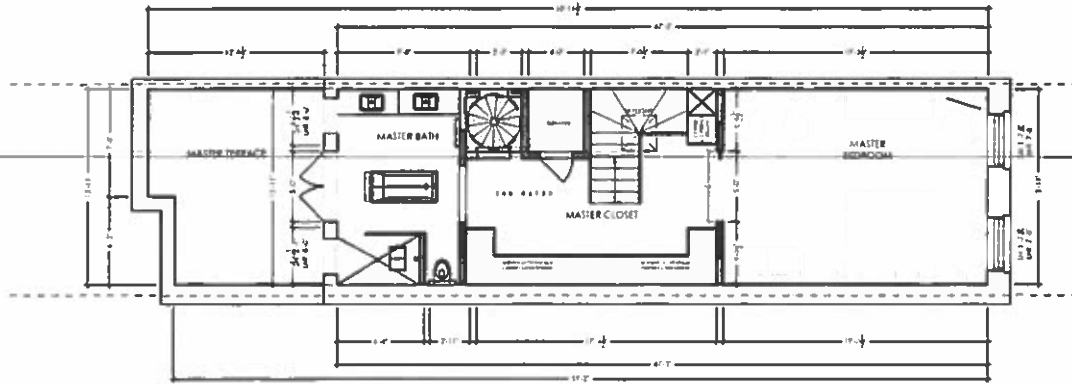

FIFTH FLOOR PLAN

THE RENOVATED HOME
THE DESIGN | RENOVATION AUTHORITY™
NYC LANDMARKS COMMISSION | 20 EAST 95TH ST | 6

Project Address:
20 East 95th Street
New York, NY 10128

Architect Name:
Joan Humphreys, RA
ARCitecture

Project Name:
The Gonzalez
De Cosio
Residence

Sheet # and Name:
Proposed
Details

Residential Townhouse:
Exterior Backyard Facade Proposal

**BLOCK 1506
EAST 94TH ST. REARS**

ZoLa
PLANNING New York City's Zoning & Land Use Map

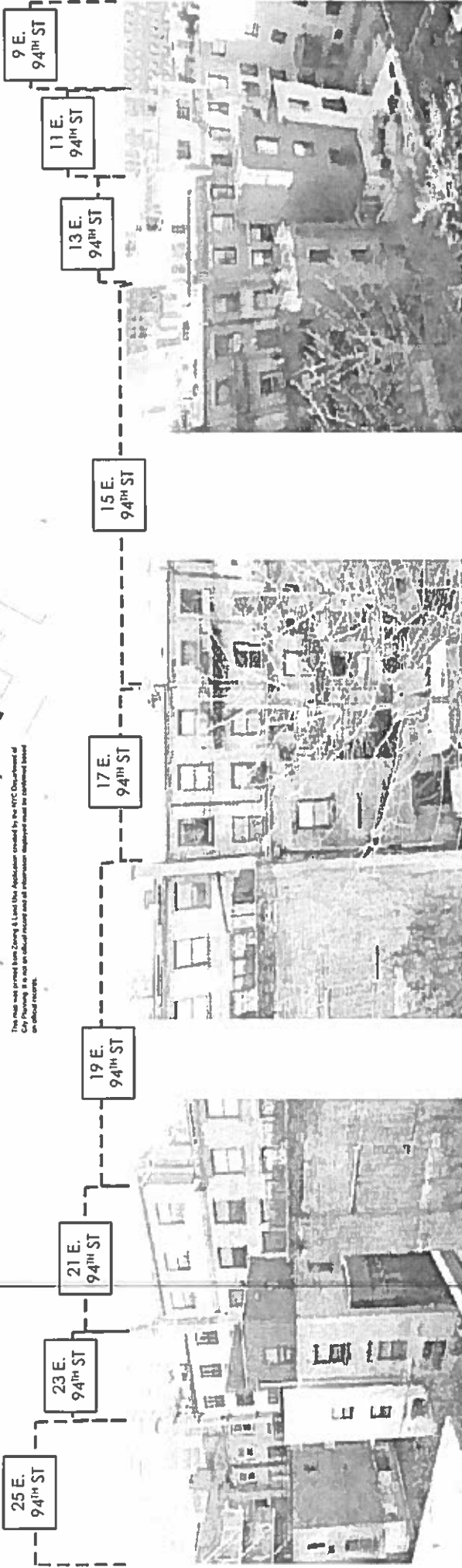
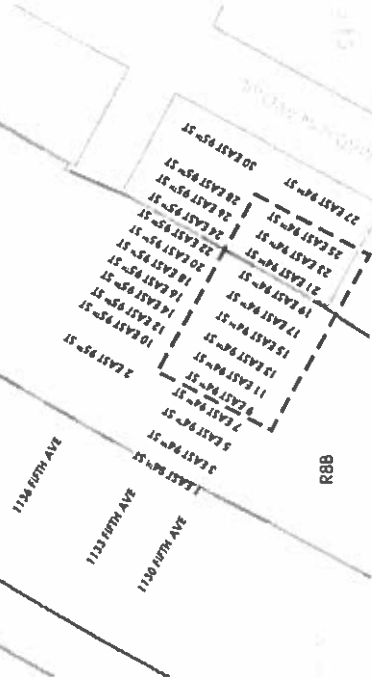

**Residential Townhouse:
Exterior Backyard Facade Proposal**

Project Name:
The Gonzalez
De Cosio
Residence

Project Address:
20 East 95th Street
New York, NY 10128

Sheet Name:
Surrounding
Neighbors:
94th St Rears

Architecture by:
Joan Humphreys, RA
ARCitecture

THE RENOVATED HOME
THE DESIGN | RENOVATION AUTHORITY™

NYC LANDMARKS COMMISSION | 20 EAST 95TH ST | 7

BLOCK 1506 EAST 95TH ST. REARS

ZoLa
PLANNING New York City's Zoning & Land Use Map

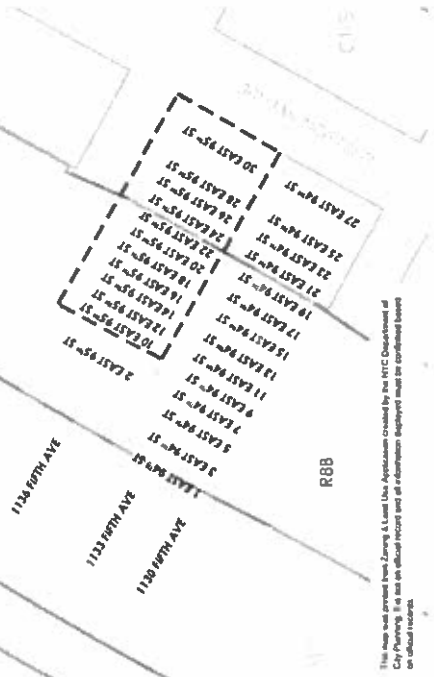

This map was prepared from Zoning & Land Use Applications created by the NYC Department of City Planning. It is not an official record and all information displayed must be confirmed based on official records.

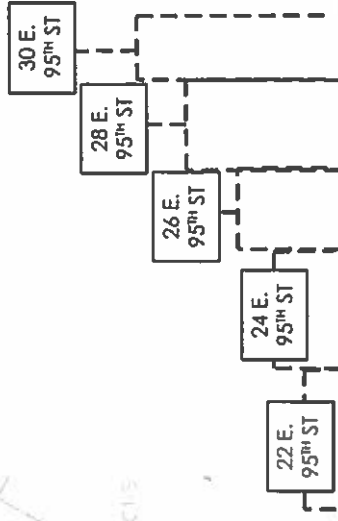
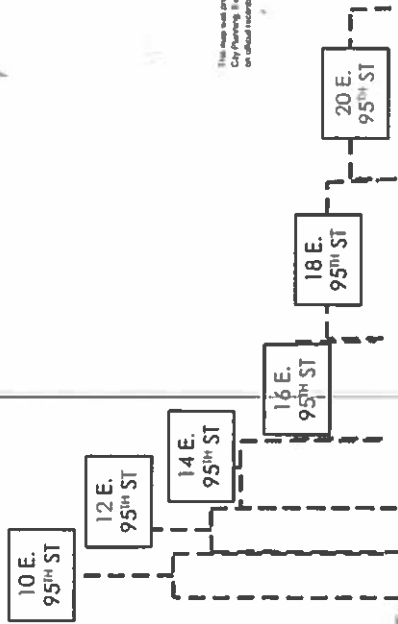

Residential Townhouse:
Exterior Backyard Facade Proposal

Project Name:
**The Gonzalez
De Cosio
Residence**

Sheet Name:
**Surrounding
Neighbors
95th St Rears**

Architecture by:
**Joan Humphreys, RA
ARCitecture**

THE RENOVATED HOME
THE DESIGN RENOVATION AUTHORITY™
NYC LANDMARKS COMMISSION | 20 EAST 95TH ST | 8

**EXISTING PHOTO WITH
PROPOSED RENDERING**



**Residential Townhouse:
Exterior Backyard Facade Proposal**

Project Name:
The Gonzalez
De Casio
Residence

Project Address:
20 East 95th Street
New York, NY 10128

Sheet Name:
Existing Photo
& Rendered
Proposed

Architecture by:
Joan Humphreys, RA
ARCitecture

THE RENOVATED HOME
THE DESIGN RENOVATION AUTHORITY, LLC
NYC LANDMARKS COMMISSION | 20 EAST 95TH ST | 9